

90° Glass-to-Glass Clamp - Square

Code No.: SC1SQ90Gxxx

* See online for available finishes
 * For glass 10 - 12mm (3/8" - 1/2")

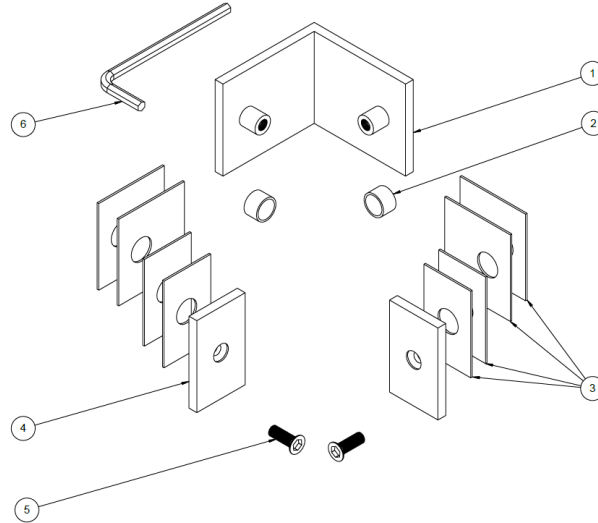
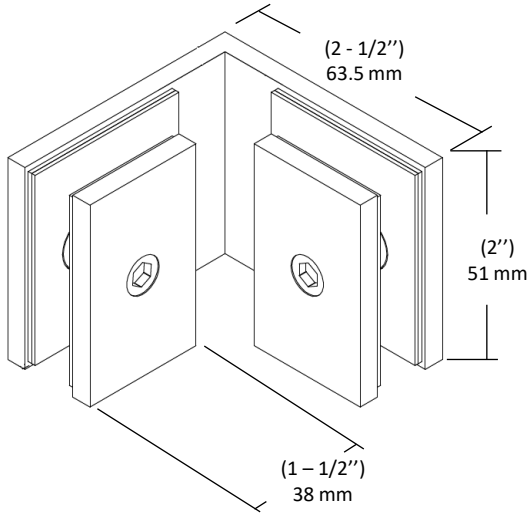

Components for 1 clamp:

SN	Name	Qty
1	Front Plate	1
2	Plastic Collar	2
3	Gasket	8
4	Back Plate	2
5	Assembly Screw	2
6	Allen Key	1

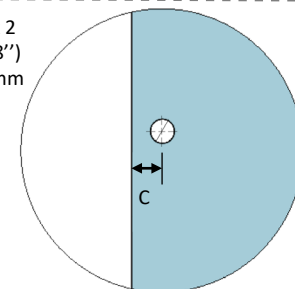
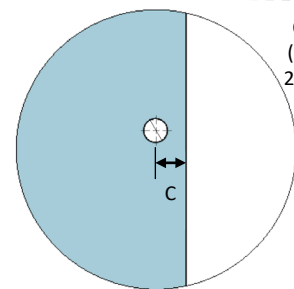
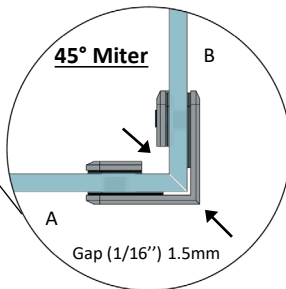
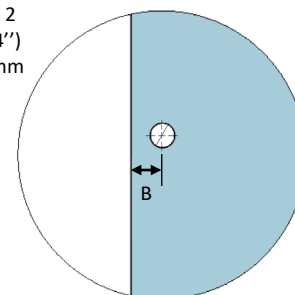
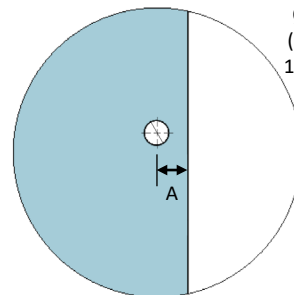
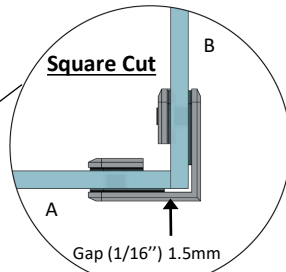
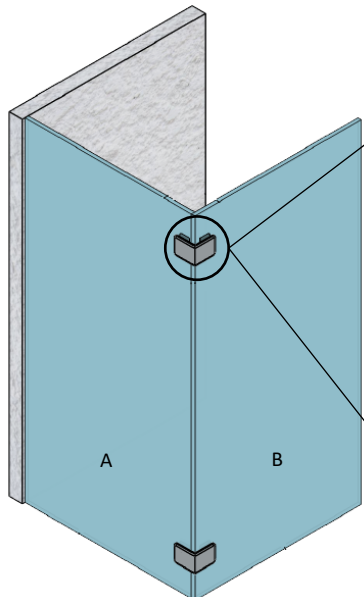

Glass Thickness	A	B
(3/8'')	(1-3/16'')	(1-5/8'')
10 mm	30 mm	41 mm
(1/2'')	(1-1/16'')	(1-5/8'')
12 mm	27 mm	41 mm

C = (1-1/2'') 38 mm

Measure From The Longest (Outside) Edge Of The Miter

* Voir en ligne pour finis disponibles
 * Pour verre 10 - 12mm (3/8" - 1/2")

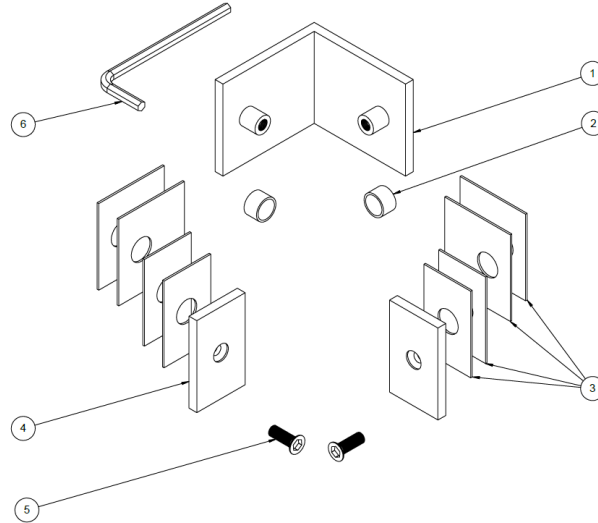
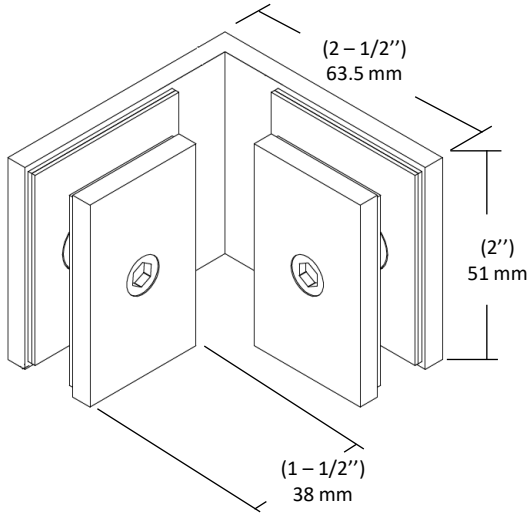

Composantes pour 1 pince

SN	Nom	Qté
1	Plaque frontale	1
2	Rondelle en plastique	2
3	Joint	8
4	Plaque arrière	2
5	Vis d'assemblage	2
6	Clé Allen	1

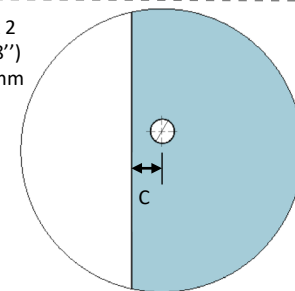
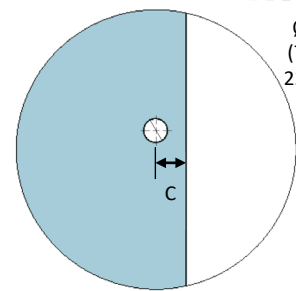
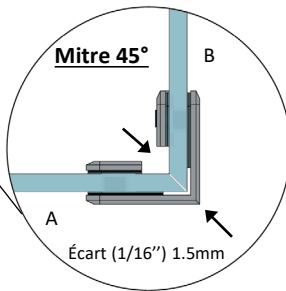
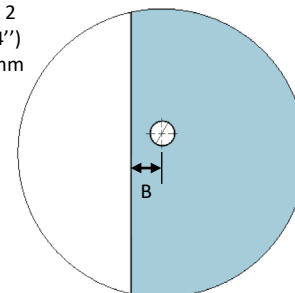
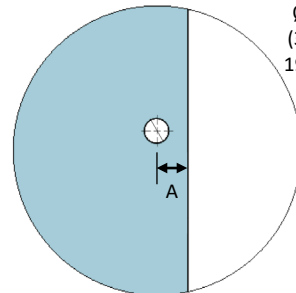
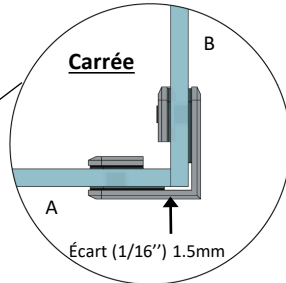
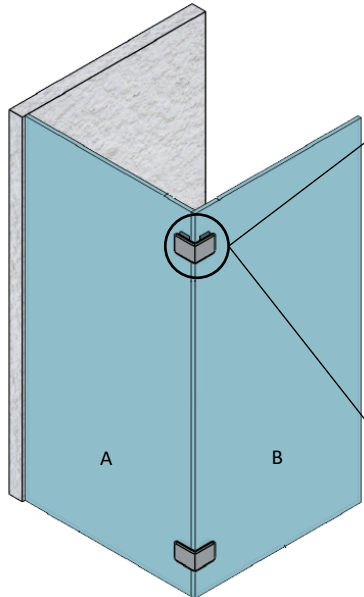

Épaisseur verre	A	B
(3/8'')	(1-3/16'')	(1-5/8'')
10 mm	30 mm	41 mm
(1/2'')	(1-1/16'')	(1-5/8'')
12 mm	27 mm	41 mm

C = (1-1/2'') 38 mm

Mesurez à partir du bord le plus long (extérieur) du mitre