

Sqaure Ladder Handle

Code	Material	H	C/C
701SQ32R60xxx	SS316	(60") 1524 mm	(48") 1219 mm

Measurements

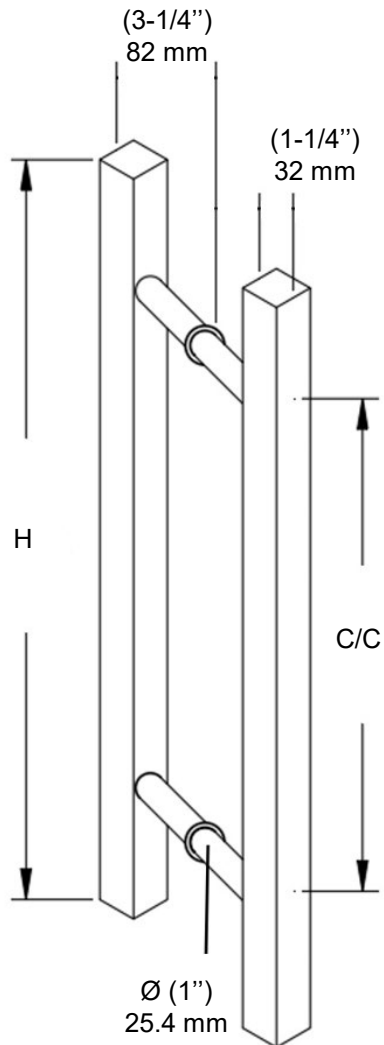
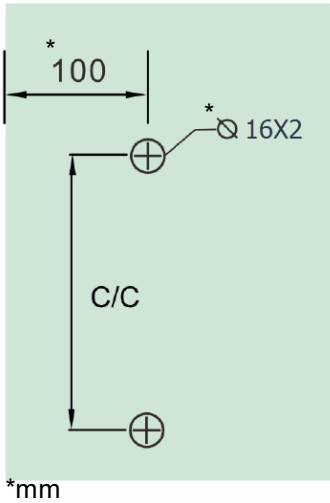

Components

#	Name	Qty
1	Exterior Handle	1
2	Interior Handle	1
3	Gasket	4
4	Metal Washer	4
5	Set Screw	4
6	Collar	2
7	Screw M6x50mm	2
8	Screw M6x90mm	2
9	Allen Key 3mm	1

Square Ladder Handle

► Installation

Install the exterior handle as shown with one gasket and metal washer on each side of the glass.

- *Philips screwdriver not included
- *Use the 50mm screw for glass doors 10-12mm thick
- *Use the 90mm screw for wood doors 35-50mm thick

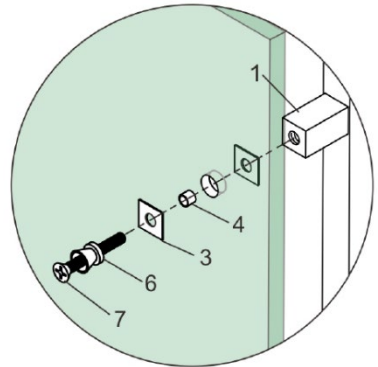

Install the interior handle onto the collars.

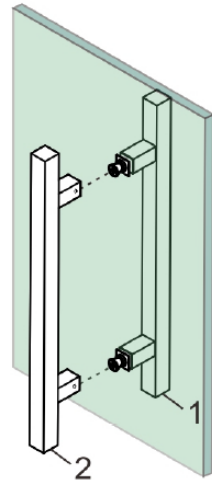

Install the set screws and tighten with the Allen key to finish the installation

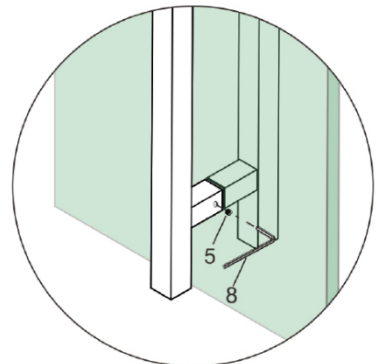

Poignée échelle carrée

Code	Matériel	H	C/C
701SQ32R60xxx	SS316	(60") 1524 mm	(48") 1219 mm

► Dimensions

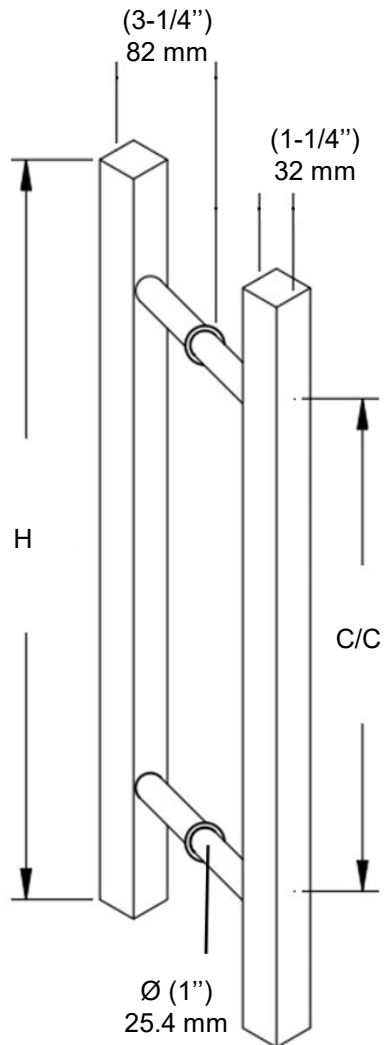
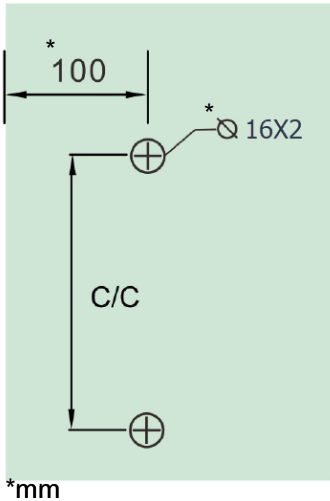

► Composantes

#	Nom	Qté
1	Poignée extérieure	1
2	Poignée intérieure	1
3	Joint	4
4	Rondelle en metal	4
5	Vis d'assemblage	4
6	Collier	2
7	Vis M6x50mm	2
8	Vis M6x90mm	2
9	Clé Allen 3mm	1

Poignée échelle carrée

► Installation

Installez la poignée extérieure comme illustré avec un joint et une rondelle métallique de chaque côté du verre.

*Tournevis Philips non inclus

*Utilisez la vis de 50 mm pour les portes en verre de 10-12 mm

*Utilisez la vis de 90 mm pour les portes en bois de 35-50 mm

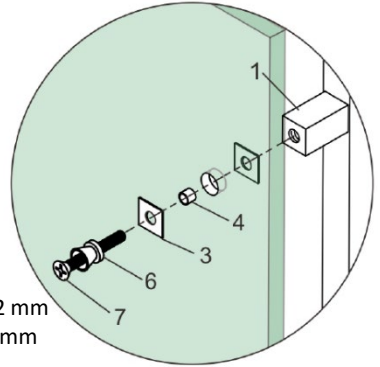

Installez la poignée intérieure sur les colliers.

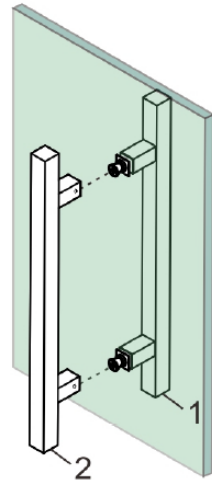

Installez les vis de réglage et serrez avec la clé Allen pour terminer l'installation

