

Combination Handle and Towel Bar

Code	Material	C/C 1	C/C 2
8702S104818xxx	SS304	(8") 203 mm	(18") 457 mm

Measurements

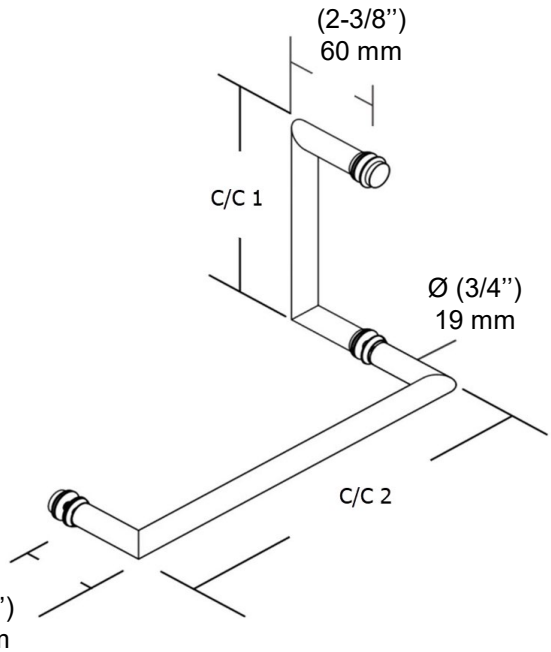
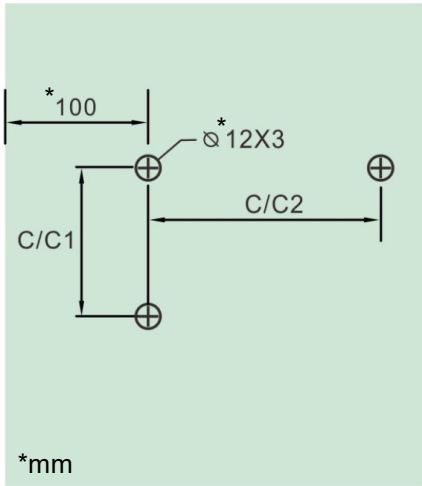

Components

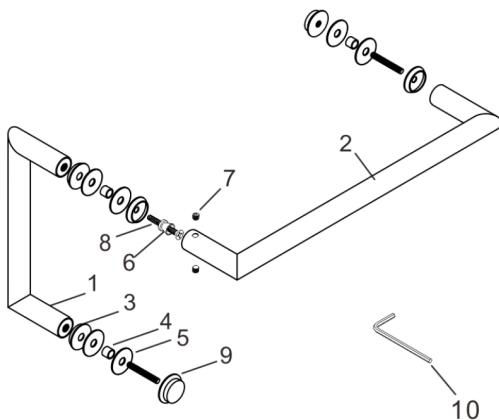

#	Name	Qty
1	Handle	1
2	Towel Bar	1
3	Metal Washer dia32mm	4
4	Plastic Washer	3
5	Gasket	6
6	Collar	1
7	Set Screw M6x6mm	2
8	Screw M6x50mm	1
9	Knob dia32mm	2
10	Allen Key 3mm	1

Combination Handle and Towel Bar

► Installation

Install the handle as shown with the screw and collar on the side that will hold the towel bar.

*Philips screwdriver not included

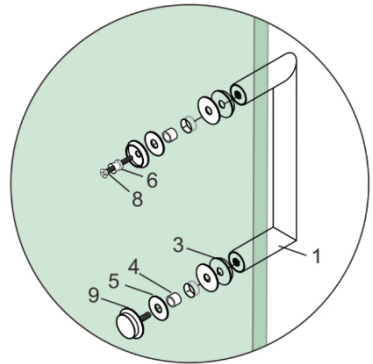

Install the towel bar with the collar on one side and the second knob on the other.

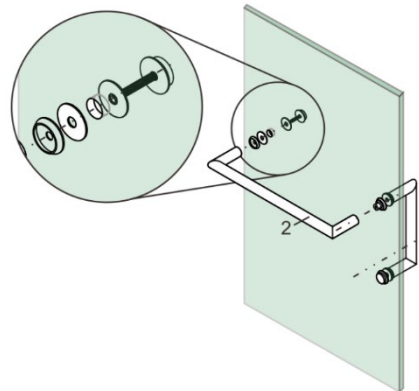

Install the set screws (7) and tighten with the Allen key (10) to finish the installation.

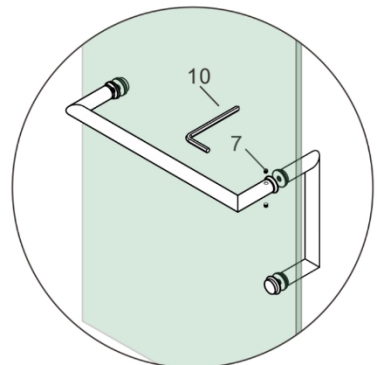

Combinaison poignée et porte-serviettes

Code	Matériel	C/C 1	C/C 2
8702S104818xxx	SS304	(8") 203 mm	(18") 457 mm

► Dimensions

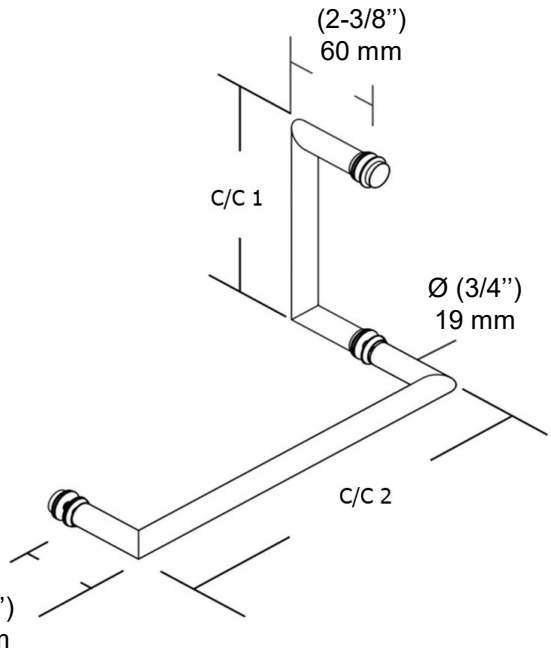
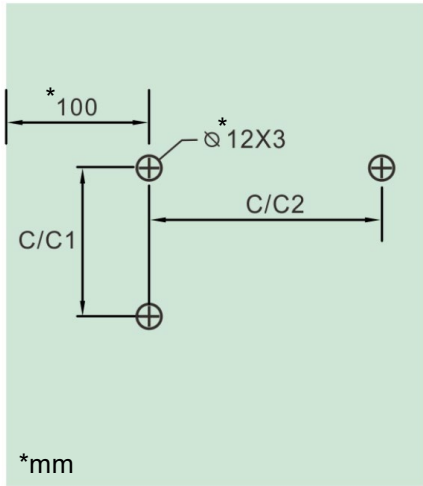

► Composantes

(2-3/8")
60 mm

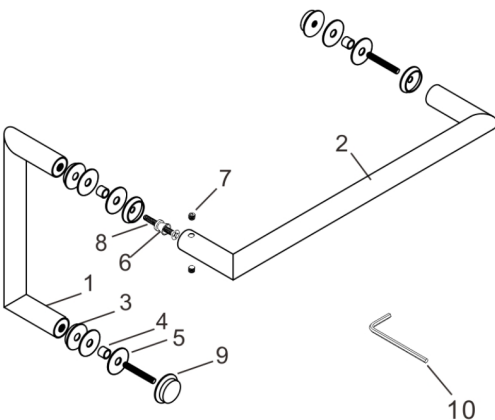

#	Nom	Qté
1	Poignée	1
2	Porte-serviette	1
3	Rondelles métal dia32mm	4
4	Rondelles plastique	3
5	Joints	6
6	Collier	1
7	Vis M6x6mm	2
8	Vis M6x50mm	1
9	Bouton dia32mm	2
10	Clé Allen 3mm	1

Combinaison poignée et porte-serviettes

► Installation

Installez la poignée comme indiqué, avec la vis et le collier du côté où se trouve le porte-serviettes.

*Tournevis Philips non inclus

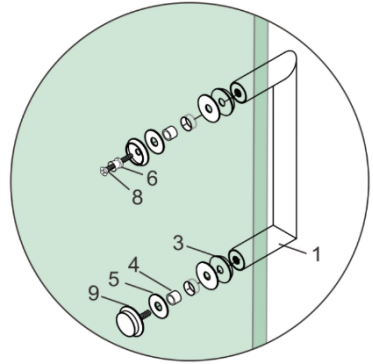

Installez le porte-serviettes avec le collier d'un côté et le deuxième bouton de l'autre.

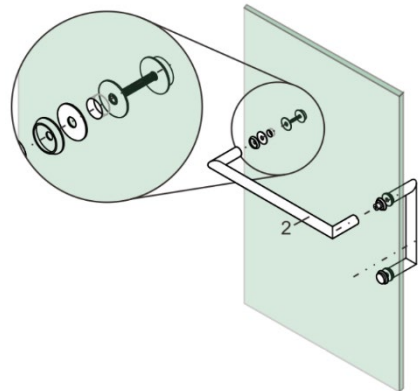

Installez les vis de réglage et serrez-les avec la clé Allen pour terminer l'installation.

