

Header extrusion

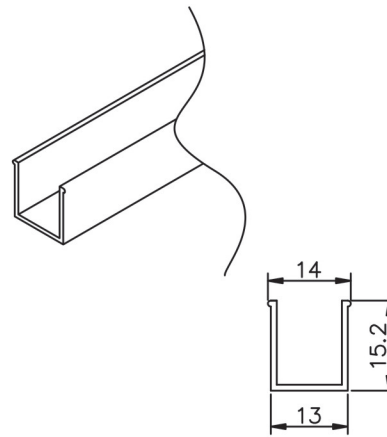

Snap-In filler insert

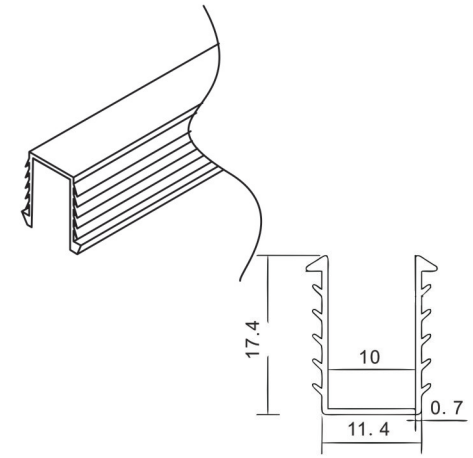

Clear glazing vinyl

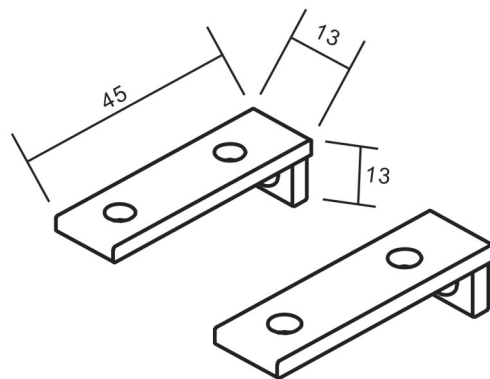

Wall mounting brackets
(per pair with mounting screw and anchor)

Length; 98"

Material	Aluminum + PVC	 Richelieu <i>PRODUITS VERRIERS</i> <i>GLAZING SUPPLIES</i>	
Finish	Chrome		
Unit	mm	Product	Euro Style Header Molding Set
		Code No.	SDH098CH